

G 1/4, G 1 Poppet Solenoid Valves

- Robust poppet design with long life expectancy under arduous condition.
- The design of face sealing on poppet makes valve 'self-cleaning' and is ideal under adverse air conditions.
- Offered in 3/8" basic and 3/4" basic version.
- Facility of gang manifolding having common inlet and exhaust.

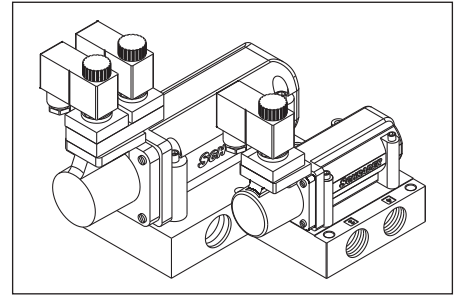

PART LIST

NO.	DESCRIPTION	QTY.	
		Single Solenoid	Double Solenoid
1	Valve body	1	1
2	Pilot housing	1	1
3	Poppet and piston assly.	1	1
4	'U' cup packing	1	1
5	Spool	1	1
6	Gasket	1	1
7	'O' ring (sub base plate)	5	5
8	Coil assembly	1	2
9	'O' ring (sub base plate)	1	2
10	'O' ring (Poppet assly.)	1	1
11	Inlet seals	1	2
12	'O' ring (pilot housing)	2	1
13	'O' ring (retainer)	1	2
14	Outlet seals	2	2
15	Spring	2	1
16	'O' ring (Double sol. hsg.)	-	4

Seal kit consists of items 4, 6, 7, 9, 10, 11, 12, 13 & 14 for single solenoid valve.

Seal kit consists of items 4, 6, 7, 9, 10, 11, 12, 13, 14 & 16 for double solenoid valve.

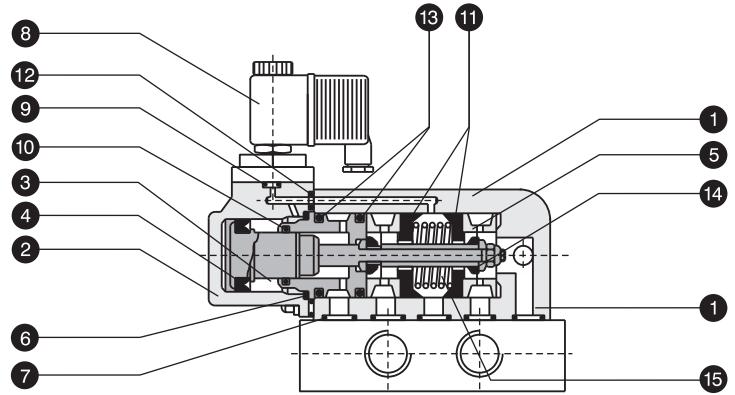

5/2 Single Solenoid Poppet Valve

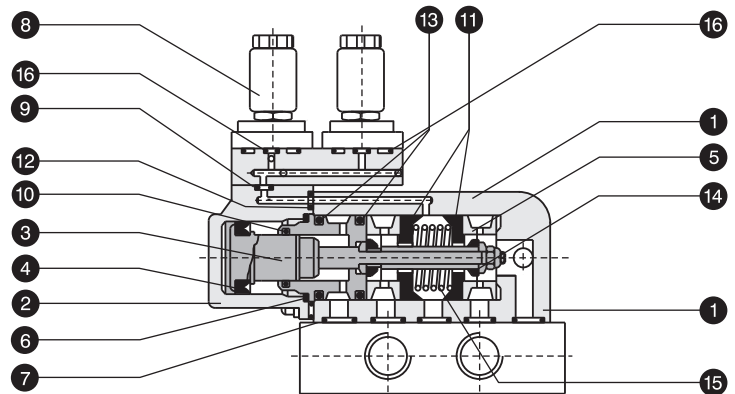

5/2 Double Solenoid Poppet Valve

COIL SPECIFICATIONS

TYPE	VALVE WITH (G25 - 3W) COIL	VALVE WITH (G50 - 10W) COIL
Construction	SS plunger with NBR seals, SS magnet core assembled with brass adaptor	
Coil Voltage	AC : 24, 110, 230V 50 HZ DC : 12, 24, 110 V	AC : 24, 110, 230V 50 HZ DC : 12, 24, 110 V
Voltage Range	±10 %	+ 10% / - 15%
Power consumption	AC : Pull : 7.5 VA, Hold : 5 VA DC : 3 WATT	AC : Pull 21VA, Hold : 14VA DC : 10 WATT
Duty cycle	100%	
Class of insulation	F (Winding wire of class 'H' insulation)	
Degree of protection	IP 65	
Cable connector	PG 9 (DIN 43650)	PG 11 (DIN 43650)

* Poppet valve is also offered with flame-proof coil duly certified by CRMS Dhanbad for grades I, IIA, IIB. Refer data sheet DPA-03 for details.

**5/2 SINGLE SOLENOID
POPPET VALVE**

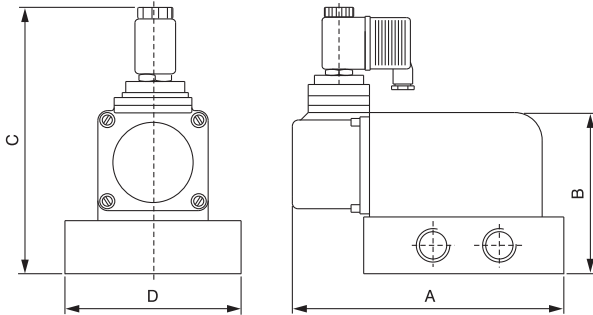
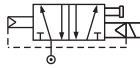

	SIZE	A	B	C	D
3/8" Basic	G 1/4	142	76	155	76
	G 3/8	142	76	155	76
	G 1/2	142	81	160	76
3/4" Basic	G 1/2	201	100	181	95
	G 3/4	201	105	186	95
	G1	206	115	196	102

SPECIFICATIONS

Medium	Compressed air, Filtered					
Design	Poppet type with air spring return					
Working pressure	1.5 - 10 kg./sq.cm.					
Ambient / fluid temp.	-10°C + 60°C					
Cv (Nominal flow)	3/8" Basic			3/4" Basic		
	1/4"	3/8"	1/2"	1/2"	3/4"	1"
	1.9	2.04	2.38	5.4	5.8	5.8
Manual override	Screw type, Detent					
Optional features	PIC with light indicator Explosion proof coil					
Response time at 5 bar	ON time : 10 m.s. OFF time : 30 m.s.					
Materials	Body, Base, pilot Housing : Aluminium Seals : NBR					

**5/2 DOUBLE SOLENOID
POPPET VALVE**

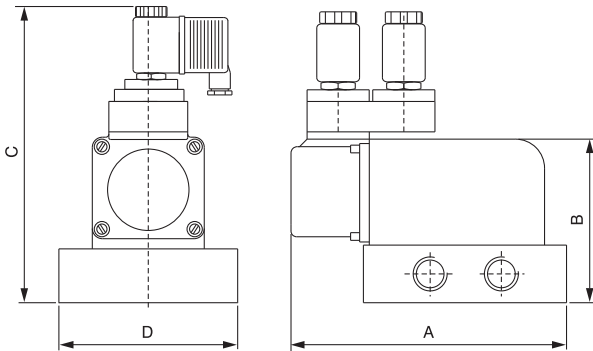
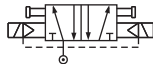

	SIZE	A	B	C	D
3/8" Basic	G 1/4	142	76	155	76
	G 3/8	142	76	155	76
	G 1/2	142	81	160	76
3/4" Basic	G 1/2	201	100	181	95
	G 3/4	201	105	186	95
	G1	206	115	196	102

SPECIFICATIONS

Medium	Compressed air, Filtered					
Design	Poppet type design					
Working pressure	1.5 - 10 kg./sq.cm.					
Ambient / fluid temp.	-10°C + 60°C					
Cv (Nominal flow)	3/8" Basic			3/4" Basic		
	1/4"	3/8"	1/2"	1/2"	3/4"	1"
	1.9	2.04	2.38	5.4	5.8	5.8
Manual override	Screw type, Detent					
Optional features	PIC with light indicator Explosion proof coil					
Response time at 5 bar	35 ms.					
Materials	Body, Base, pilot Housing : Aluminium Seals : NBR					

ORDERING INFORMATION

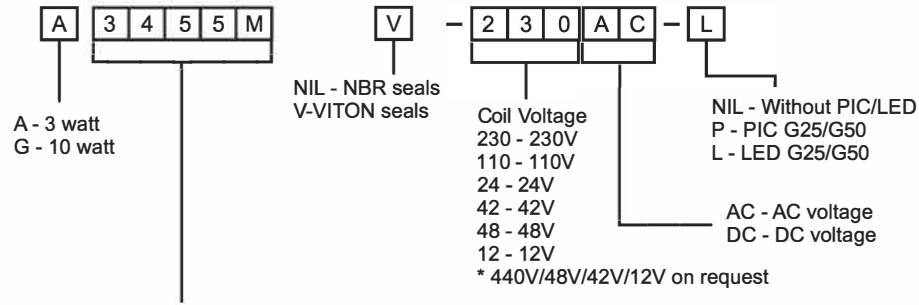

Type	Port	Single Sol. with base	Single Sol. w/o base	Double Sol. with base	Double Sol. w/o base
3/8" Basic	1/4" BSP	3455M	2455M	825MD	725MD
	3/8" BSP	3456M	2456M	826MD	726MD
	1/2" BSP	3461M	2461M	830MD	730MD
3/4" Basic	1/2" BSP	3457M	2457M	827MD	727MD
	3/4" BSP	3458M	2458M	828MD	728MD
	1" BSP	3459M	2459M	829MD	729MD
	1-1/4" BSP	3460M	2460M	831MD	731MD

Model Offered - A3461M Voltage?
Please confirm the voltage before placing your Purchase Order.

ORDERING INFORMATION SEALKIT

Type	Port	Base	Seal kit single sol.	Seal kit double sol.
3/8 Basic	1/4"	PBS3814	SK3456M	SK826MD
	3/8"	PBS3838	SK3456M	SK826MD
	1/2"	PBS3812	SK3456M	SK826MD
3/4 Basic	1/2"	PBS3412	SK3458M	SK828MD
	3/4"	PBS3434	SK3458M	SK828MD
	1"	PBS3410	SK3458M	SK828MD
	1-1/4"	PBS34114	SK3458M	SK828MD